

WPS.006

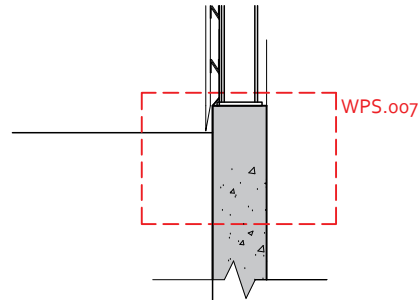

WPS.007

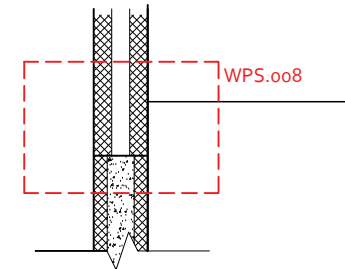

WPS.008

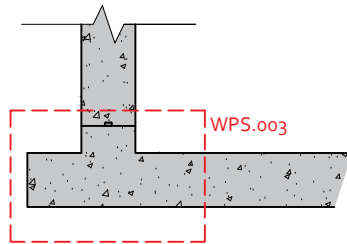

WPS.003

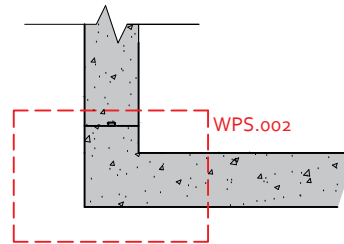

WPS.002

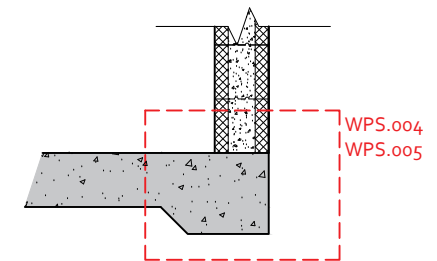

WPS.004
WPS.005

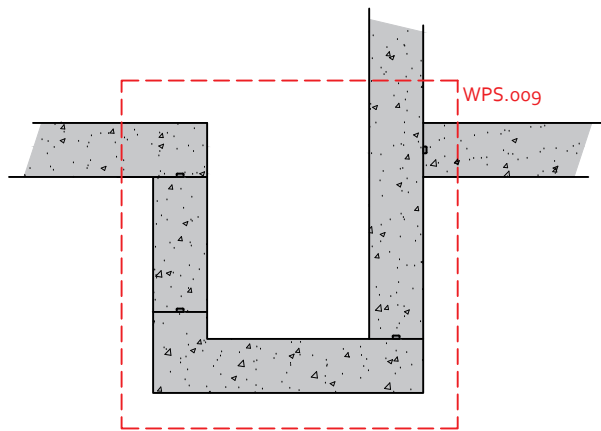

WPS.009

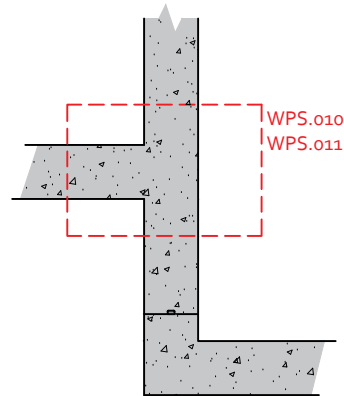

WPS.010
WPS.011

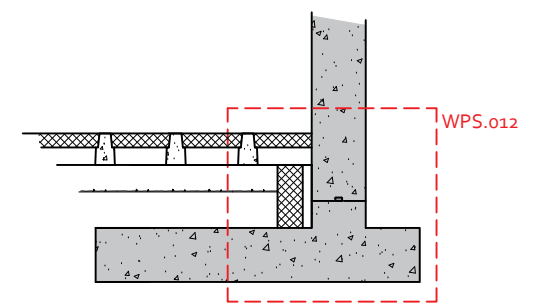

WPS.012

CLIENT JUTA UK LTD

PROJECT Cavity Drain Standard Details



NOTES

- Detail is generic to application so should be used as a guide not a specific installation detail.
- JUTA suggest that waterproofing membranes including JUTA WP SAM should be installed by suitably experienced persons. If unfamiliar with products and applications, please contact JUTA for Specialist Contractors Details.
- JUTA WP SAM can be applied to reinforced concrete, concrete blockwork and masonry. It can also be applied to various masonry wall systems (i.e. ICF or Stepoc.) but please contact JUTA or a specialist to confirm suitability of primers and adhesive on structure.
- All surfaces must be prepared with 2 coats of JUTA GP Primer before application. A minimum of 2hrs must be left between coats to allow the primer to become tacky to aid adhesion. Please refer to JUTA WP SAM Installation Guide for further information
- All externally applied membrane should be protected from damage prior to backfilling. This can be achieved using standard protection boards or better still, JUTA PD1700 which is a protection and drainage sheet layer which additionally creates a void between the membrane and earth to reduce the change of hydrostatic pressure onto the structure and direct any groundwater to land drain locations.
- All design decisions made by others that might have an impact on the gas and waterproof design performance should be brought to the attention of the design team and Juta UK Ltd. Final decisions and/or any recommendations should be approved by the design team and Juta UK Ltd.
- Dimensions are not to be scaled from this drawing. All written measurements are to be checked on site by the contractor.
- All rights described in chapter IV of the copyright, design and patents act 1988 have been generally asserted.

DRAWING TITLE
JUTA WP SAM (SELF ADHESIVE MEMBRANE)
TYPICAL DETAIL REFERENCE KEY

DRAWING NUMBER
JUTA.WPS.001

DRAWN BY PD	CHECKED BY PF	SCALE Not to Scale	DATE Mar. 2020
----------------	------------------	-----------------------	-------------------

 MELTON GROVE WORKS
BLACKPOOL ROAD
LYTHAM
FY8 5PL
Tel: 01772 754177